

FINA
TEHNO
LED

Contents

07 Light Panels



19 Down light Panels

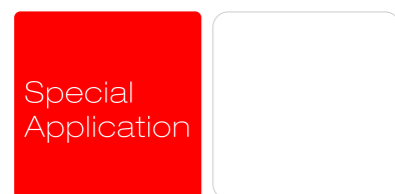

31 Installation Guide



43 Power supply Guide

Light Panels

3030 3060 6060 30120 60120

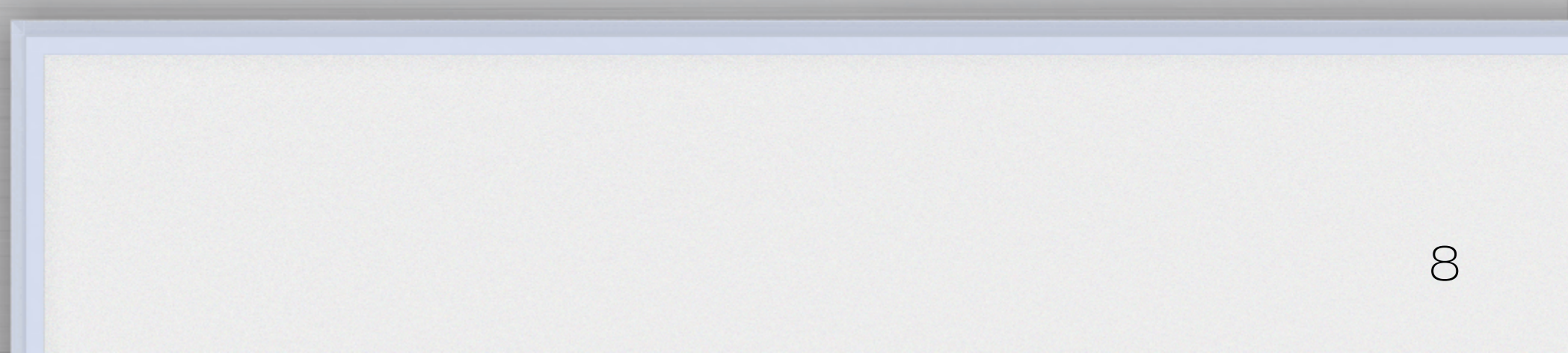
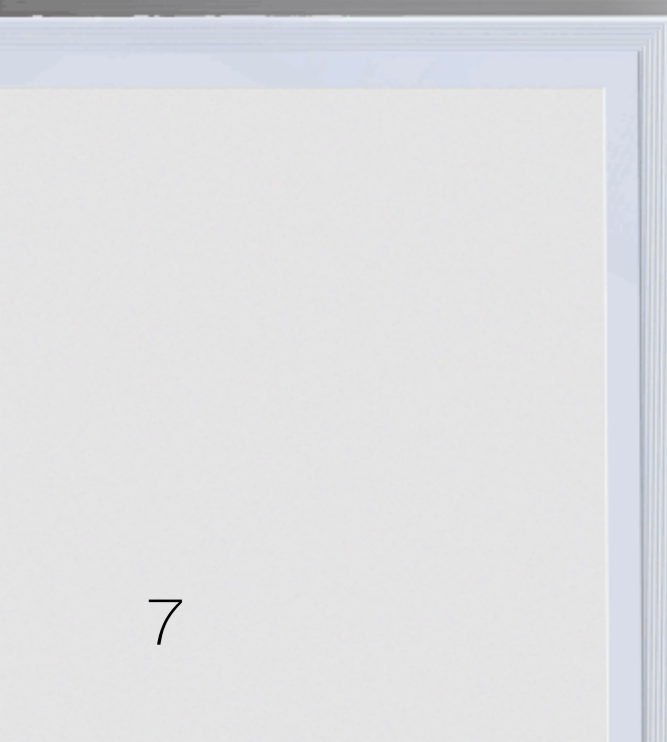
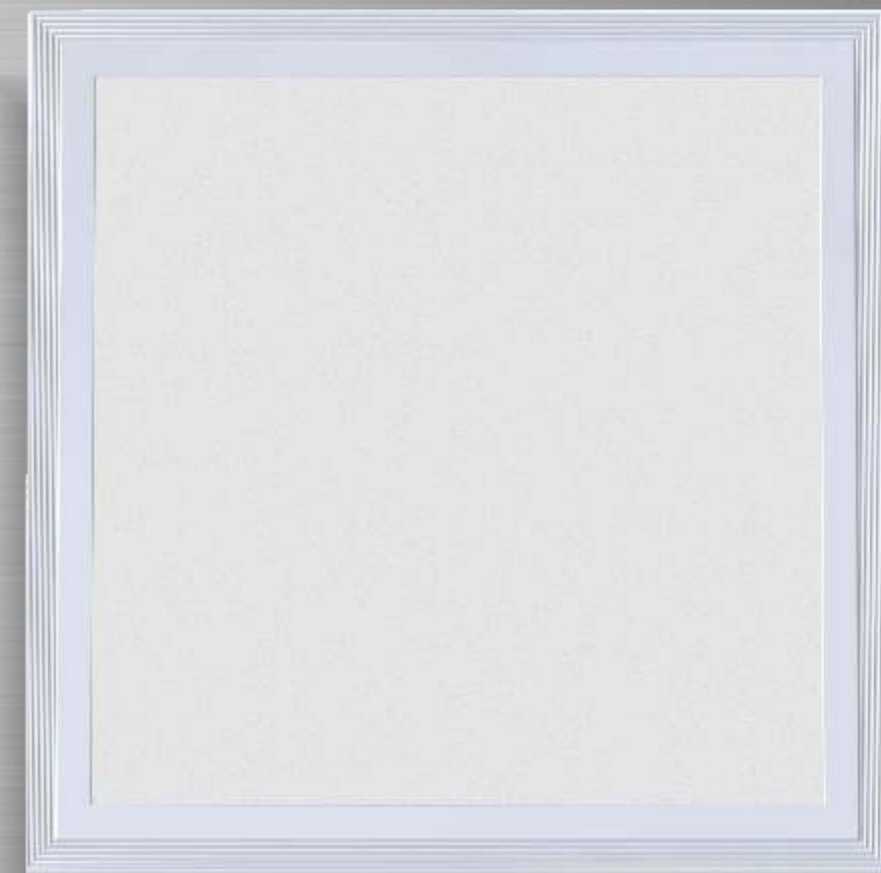

3030



80
lm/w

70
lm/w

MODEL:	3030-100	3030-75
CW:	1522	1218
NW:	1431	1145
WW:	1355	1084
DEFAULT POWER:	19W	19W
POWER RANGE:	10-20W	10-20W
WARRANTY:	5 yrs	3 yrs
LIFE:	70,000hrs	45,000hrs
LM80@6Khrs:	>96.8%	>92%
INPUT VOLTAGE:	180~240Vac/100-240Vac	
PF:	>0.9	
DRIVER OUTPUT:	36V/450MA	
THD:	<0.2	
DIM SOLUTION:	Optional Dali/0-10V/PWM/Traic	

Dimension

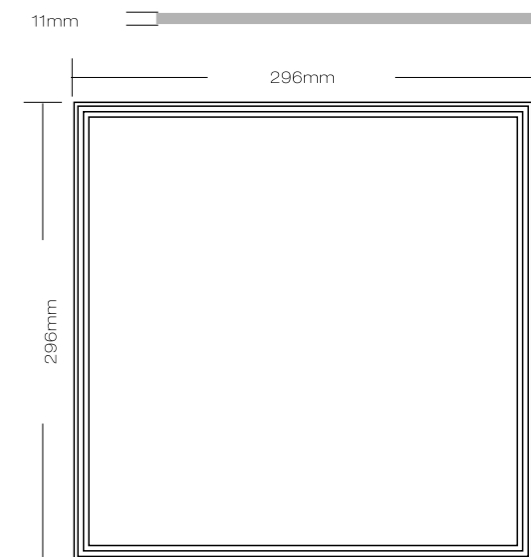

3060



	80 lm/w	85 lm/w	70 lm/w
MODEL:	3060-100 -20W	3060-100 -40W	3060-75 -42W
CW:	1553	3448	2758
NW:	1506	3241	2593
WW:	1398	3069	2455
DEFAULT POWER:	20W	40W	42W
POWER RANGE:	10-20W	30-50W	30-43W
WARRANTY:	5 yrs	5 yrs	3 yrs
LIFE:	70,000hrs	70,000hrs	45,000hrs
LM80@6Khrs:	>96.8%	>96.8%	>92%
INPUT VOLTAGE:	180~240Vac/100-240Vac		
PF:	>0.9		
DRIVER OUTPUT:	36V/450MA	36V/1000MA	
THD:	<0.2		
DIM SOLUTION:	Optional Dali/0-10V/PWM/Traic		

DIMENSION 3060

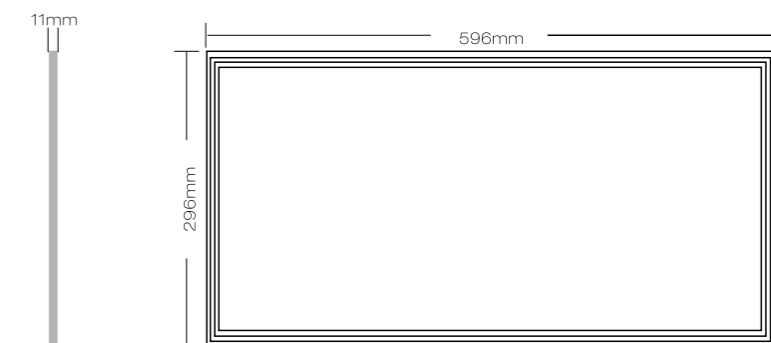

6060



	120 lm/w	95 lm/w	90 lm/w	80 lm/w	70 lm/w
MODEL:	6060-115	6060-100	6060-90	6060-80	6060-70
CW:	3015	4608	4224	3806	3396
NW:	3120	4470	4097	3653	3294
WW:	2830	4147	3802	3501	3056
DEFAULT POWER:	26W	48W	48W	48W	48W
POWER RANGE:	20-30W	30-50W	30-50W	30-50W	30-50W
WARRANTY:	6 yrs	5 yrs	3 yrs	3 yrs	2 yrs
LIFE:	80,000hrs	70,000hrs	65,000hrs	60,000hrs	45,000hrs
LM80@6Khrs:	>98.8%	>96.8%	>96.8%	>94.2%	>92%
INPUT VOLTAGE:	100-240Vac	180-240Vac/100-240Vac			
PF:	>0.9	>0.9			
DRIVER OUTPUT:	36V/700MA	36V/1000MA			
THD:	<0.2	<0.2			
DIM SOLUTION:	-	Optional Dali/0-10V/PWM/Traic			

	115 lm/w	100 lm/w	90 lm/w	80 lm/w	75 lm/w	70 lm/w
MODEL:	6060-115	6060-100	6060-90	6060-80	6060-75	6060-70
CW:	4520	4016	3720	3566	3109	2640
NW:	4384	3895	3608	3388	3069	2561
WW:	4068	3503	3348	3050	2749	2376
DEFAULT POWER:	40W	40W	40W	43W	42W	42W
POWER RANGE:	30-50W	30-50W	30-50W	30-50W	30-43W	30-43W
WARRANTY:	6 yrs	5 yrs	4 yrs	3 yrs	3 yrs	2 yrs
LIFE:	80,000hrs	70,000hrs	65,000hrs	60,000hrs	45,000hrs	40,000hrs
LM80@6Khrs:	>98.8%	>96.8%	>96.8%	>94.2%	>92%	>92%
INPUT VOLTAGE:	180-240Vac/100-240Vac					
PF:	>0.9					
DRIVER OUTPUT:	36V/1000MA					
THD:	<0.2					
DIM SOLUTION:	Optional Dali/0-10V/PWM/Traic					

Dimension



Regular Size

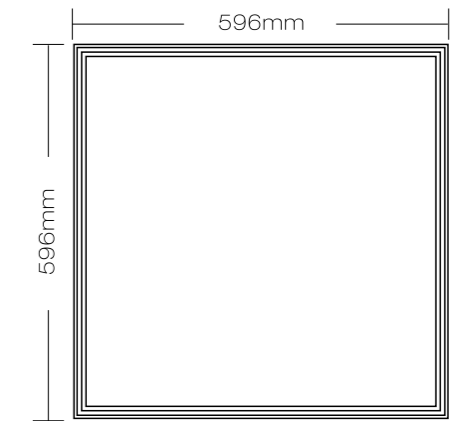

Germany Size

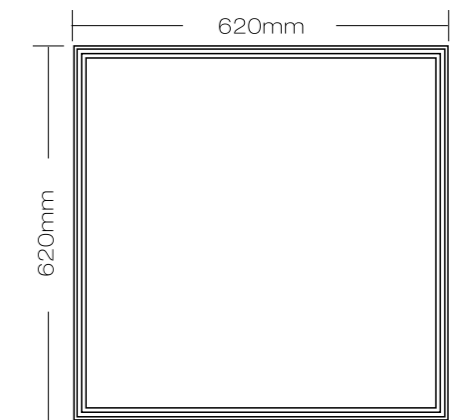

UL Size

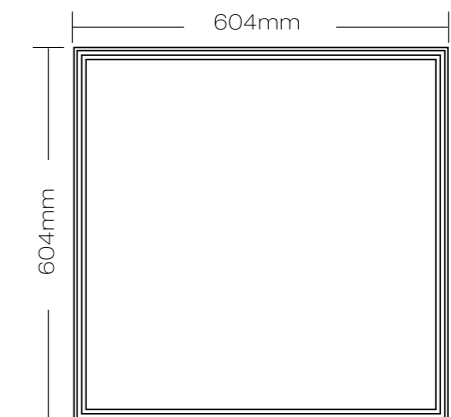



30120



	90 lm/w	75 lm/w	70 lm/w
MODEL:	30120-100	30120-80	30120-75
CW:	3640	3080	2820
NW:	3531	3040	2679
WW:	3276	2898	2545
DEFAULT POWER:	40W	40W	42W
POWER RANGE:	30-50W	30-50W	30-42W
WARRANTY:	5 yrs	3 yrs	3 yrs
LIFE:	70,000hrs	60,000hrs	45,000hrs
LM80@6Khrs:	>96.8%	>94.2%	>92%
INPUT VOLTAGE:	180~240Vac/100-240Vac		
PF:	>0.9		
DRIVER OUTPUT:	36V/1000MA		
THD:	<0.2		
DIM SOLUTION:	Optional Dali/0-10V/PWM/Traic		

	90 lm/w	75 lm/w	70 lm/w
MODEL:	30120-100	30120-80	30120-75
CW:	6381	5232	5105
NW:	5998	4918	4798
WW:	5679	4656	4543
DEFAULT POWER:	76W	76W	76W
POWER RANGE:	50-80W	50-80W	50-80W
WARRANTY:	5 yrs	3 yrs	3 yrs
LIFE:	70,000hrs	60,000hrs	45,000hrs
LM80@6Khrs:	>96.8%	>94.2%	>92%
INPUT VOLTAGE:	180~240Vac/100-240Vac		
PF:	>0.9		
DRIVER OUTPUT:	36V/1800MA		
THD:	<0.2		
DIM SOLUTION:	Optional Dali/0-10V/PWM/Traic		

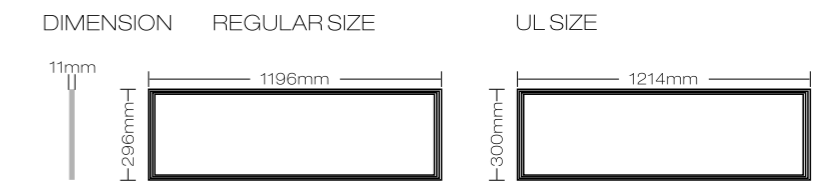



60120



	90 lm/w	75 lm/w	70 lm/w
MODEL:	60120-100	60120-80	60120-75
CW:	5486	4663	4084
NW:	5321	4523	3838
WW:	4938	4197	3634
DEFAULT POWER:	60W	60W	60W
POWER RANGE:	50-80W	50-80W	50-80W
WARRANTY:	5 yrs	3 yrs	3 yrs
LIFE:	70,000hrs	60,000hrs	45,000hrs
LM80@6Khrs:	>96.8%	>94.2%	>92%
INPUT VOLTAGE:	180-240Vac/100-240Vac		
PF:	>0.9		
DRIVER OUTPUT:	36V/1400MA		
THD:	<0.2		
DIM SOLUTION:	Optional Dali/0-10V/PWM/Traic		

	90 lm/w	80 lm/w	70 lm/w
MODEL:	60120-100	60120-80	60120-75
CW:	7125	6128	5105
NW:	6911	5943	4798
WW:	6413	5515	4543
DEFAULT POWER:	76W	76W	76W
POWER RANGE:	50-80W	50-80W	50-80W
WARRANTY:	5 yrs	3 yrs	3 yrs
LIFE:	70,000hrs	60,000hrs	45,000hrs
LM80@6Khrs:	>96.8%	>94.2%	>92%
INPUT VOLTAGE:	180-240Vac/100-240Vac		
PF:	>0.9		
DRIVER OUTPUT:	36V/1800MA		
THD:	<0.2		
DIM SOLUTION:	Optional Dali/0-10V/PWM/Traic		

DIMENSION REGULAR SIZE UL SIZE

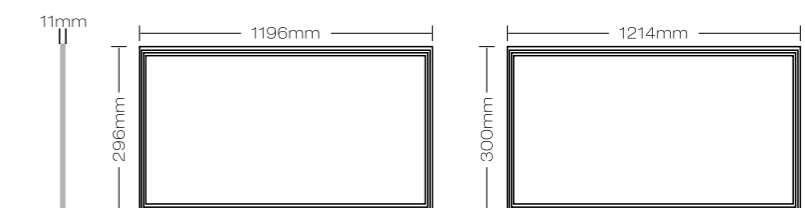

Down Light Panels





Round

R3 R5 R6 R7 R8 R9



	R3	R5	R6	R7	R8	R9
CW:	218	422	675	1031	1297	1633
NW:	212	407	654	1001	1259	1558
WW:	201	386	621	951	1196	1480
DEFAULT POWER:	3.5W	6W	9W	12W	15W	18W
POWER RANGE:	3-6W	6-9W	9-12W	12-15W	15-18W	18-22W
PF:	0.5	0.5	0.9	0.9	0.9	0.9
DRIVER OUTPUT:	9V/300MA	18V/300MA	27V/300MA	36V/300MA	36V/380MA	36V/450MA
WARRANTY:	3 yrs					
LIFE:	35,000hrs					
LM80@6Khrs:	>94.2%					
INPUT VOLTAGE:	100-240Vac					
DIM SOLUTION:	Optional Dali/0-10V/PWM/Traic					

R3

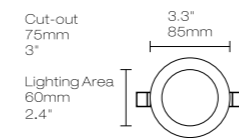

R5

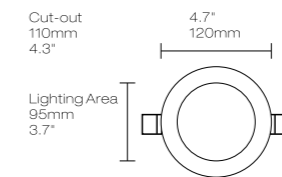

R6

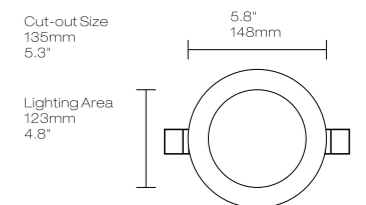

R7

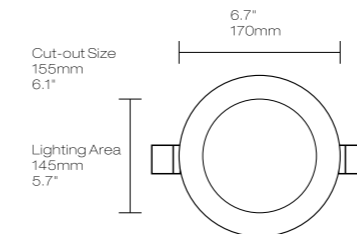

R8

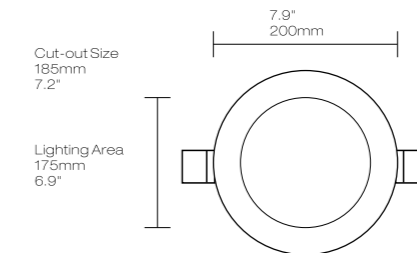

R9

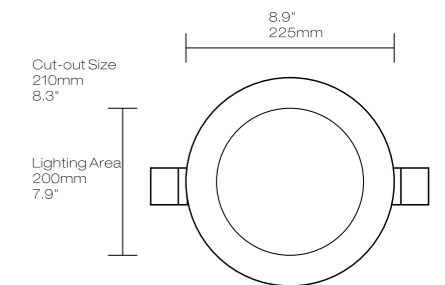



Square

R3 R5 R6 R7 R8 R9



	R3	R5	R6	R7	R8	R9
CW:	221	457	628	917	1233	1453
NW:	215	444	610	890	1197	1411
WW:	204	422	580	846	1137	1340
DEFAULT POWER:	3.5W	6W	9W	12W	15W	18W
POWER RANGE:	3-6W	6-9W	9-12W	12-15W	15-18W	18-22W
PF:	0.5	0.5	0.9	0.9	0.9	0.9
DRIVER OUTPUT:	9V/300MA	18V/300MA	27V/300MA	36V/300MA	36V/380MA	36V/450MA
WARRANTY:	3 yrs					
LIFE:	35,000hrs					
LM80@6Khrs:	>94.2%					
INPUT VOLTAGE:	100-240Vac					
DIM SOLUTION:	Optional Dali/0-10V/PWM/Traic					

S3

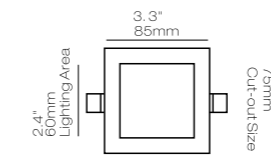

S5

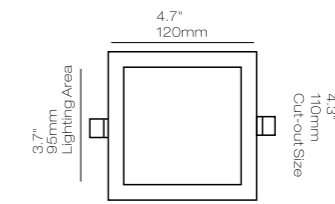

S6

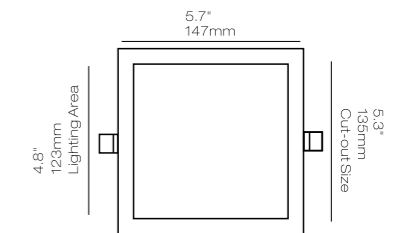

S7

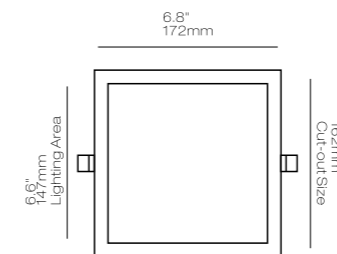

S8

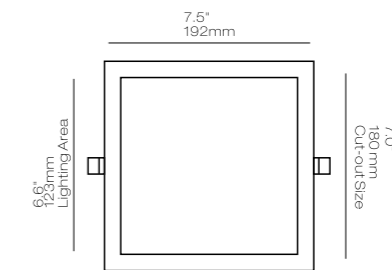

S9

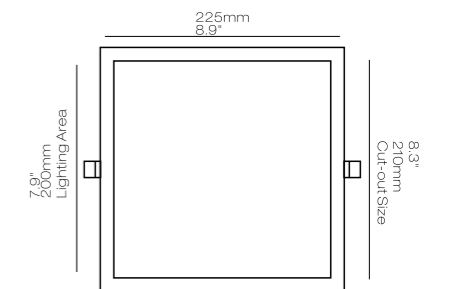

Surface Mounted Round

R5 R7 R9



	R5	R7	R9
CW:	422	1031	1633
NW:	407	1001	1558
WW:	386	951	1480
DEFAULT POWER:	6W	12W	18W
POWER RANGE:	6-9W	12-15W	18-22W
PF:	0.5	0.9	0.9
DRIVER OUTPUT:	18V/300MA	36V/300MA	36V/450MA
WARRANTY:	3 yrs		
LIFE:	35,000hrs		
LM80@6Khrs:	>94.2%		
INPUT VOLTAGE:	100-240Vac		
DIM SOLUTION:	Optional Dali/0-10V/PWM/Traic		

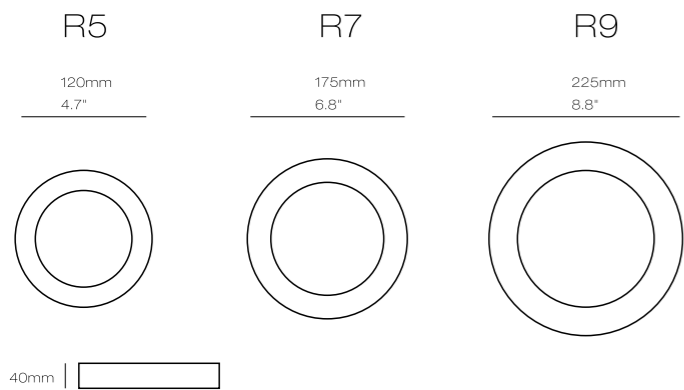

Surface Mounted Square

R5 R7 R9



	R5	R7	R9
CW:	457	917	1453
NW:	444	890	1411
WW:	422	846	1340
DEFAULT POWER:	6W	12W	18W
POWER RANGE:	6-9W	12-15W	18-22W
PF:	0.5	0.9	0.9
DRIVER OUTPUT:	18V/300MA	36V/300MA	36V/450MA
WARRANTY:	3yrs		
LIFE:	35,000hrs		
LM80@6Khrs:	>94.2%		
INPUT VOLTAGE:	100-240Vac		
DIM SOLUTION:	Optional Dali/0-10V/PWM/Traic		

R5

4.7"
120mm

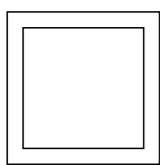

R7

6.7"
172mm

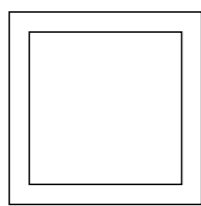

R9

8.6"
220mm

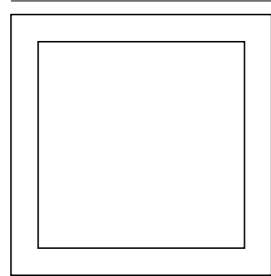



IP 65



MODEL:	115-W6060	115-W1590	115-W15120
CW:	4016	2800	2855
NW:	3895	2720	2768
WW:	3503	2388	2412
DEFAULT POWER:	40W	40W	40W
POWER RANGE:	30-50W	30-50W	30-50W
WARRANTY:	3 yrs		
LIFE:	50,000hrs		
LM80@6Khrs:	>96.8%		
INPUT VOLTAGE:	180~240Vac/100-240Vac		
PF:	>0.9		
DRIVER OUTPUT:	36V/1000MA		
THD:	<0.2		
DIM SOLUTION:	Optional Dali/0-10V/PWM/Traic		

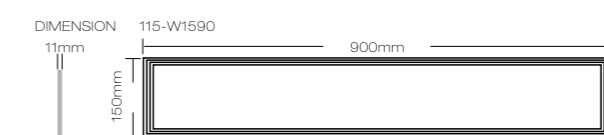
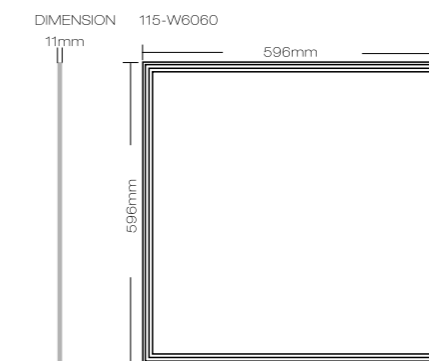

Features

Ip65 & IK06, water-proof, easy cleaning.

Applications:
Clean Room, Pharmaceutical Factory,
Coating Workshop, Cold Storage etc.



Installation

— Recessed

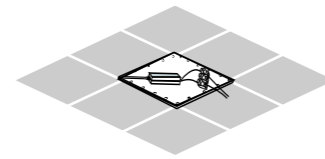

— Suspension



— Frame mounted



— Ceiling & Wall mounted



— Recessed with clip



1

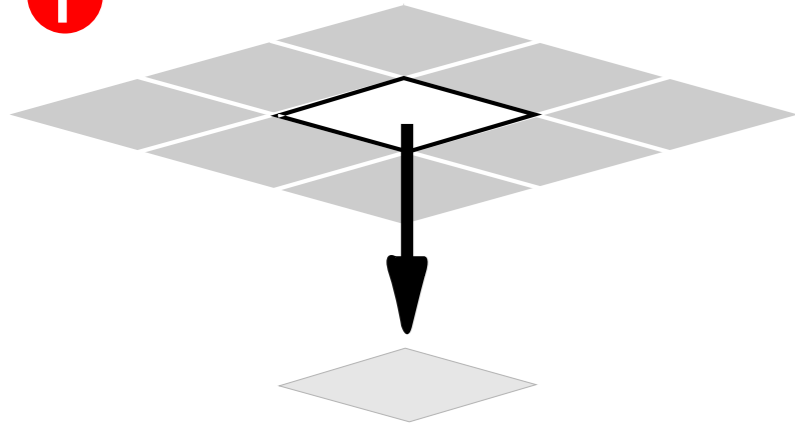

4

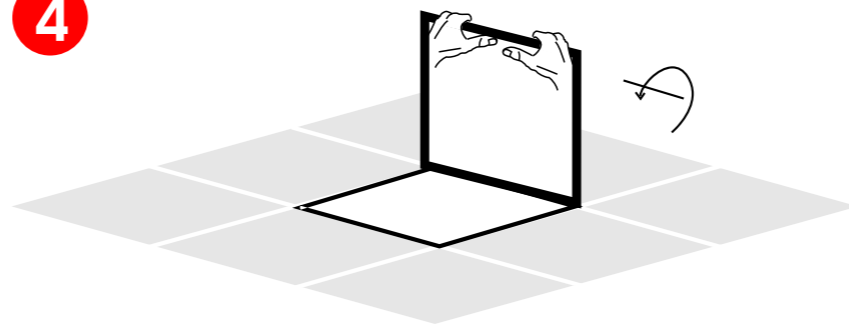

7

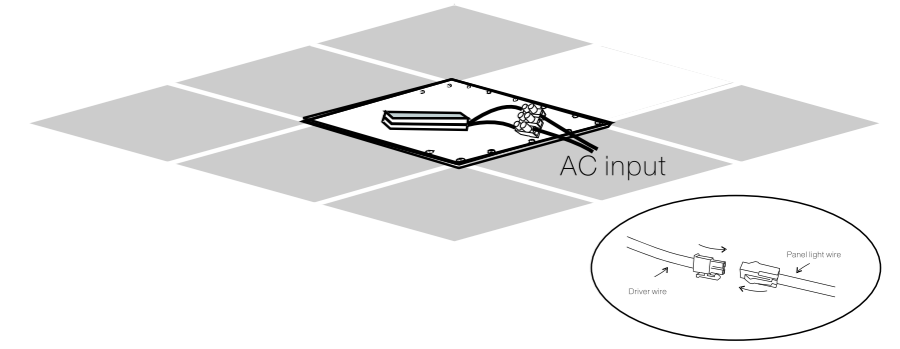

2

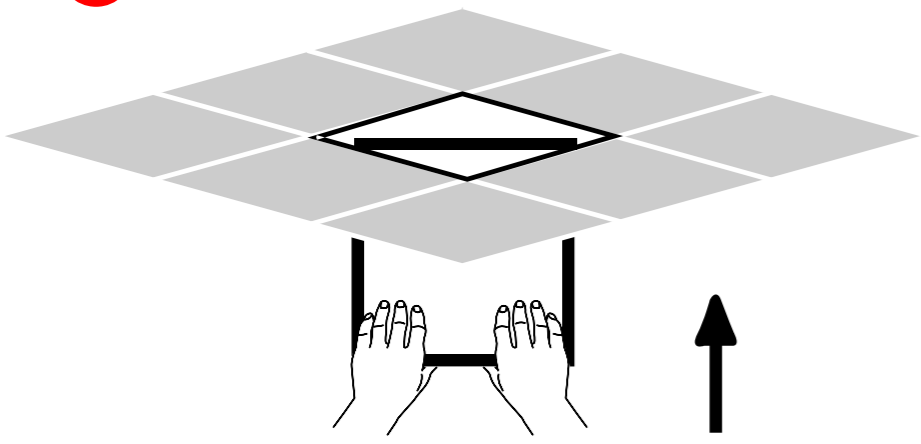

5

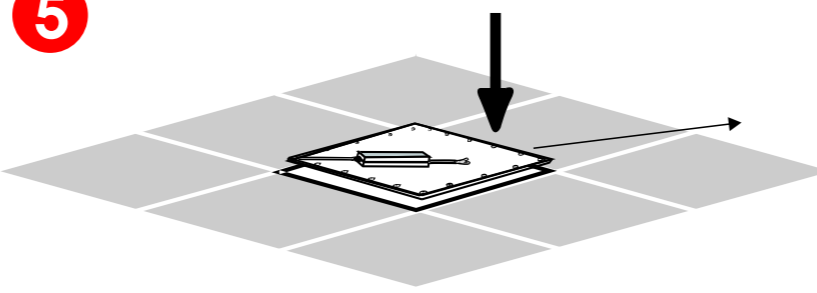

8

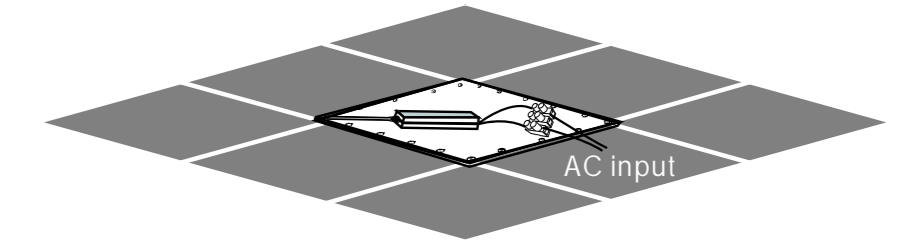

3

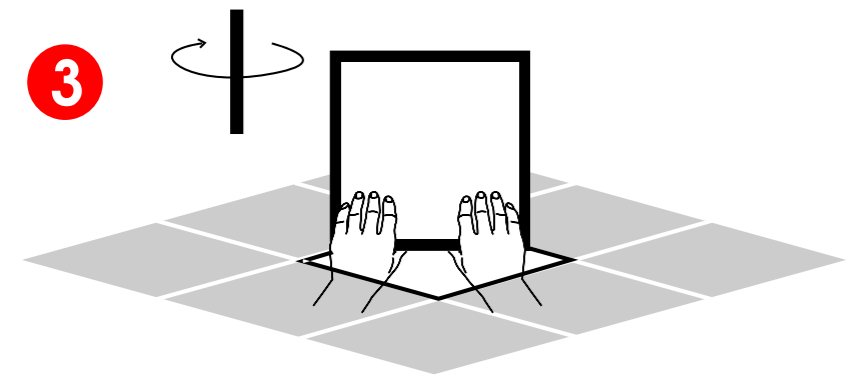

6

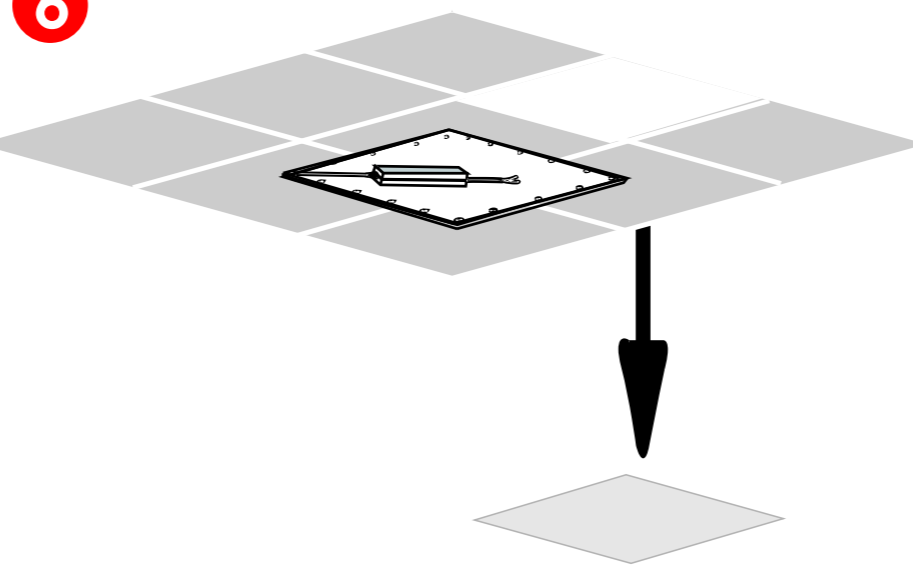

Suspension

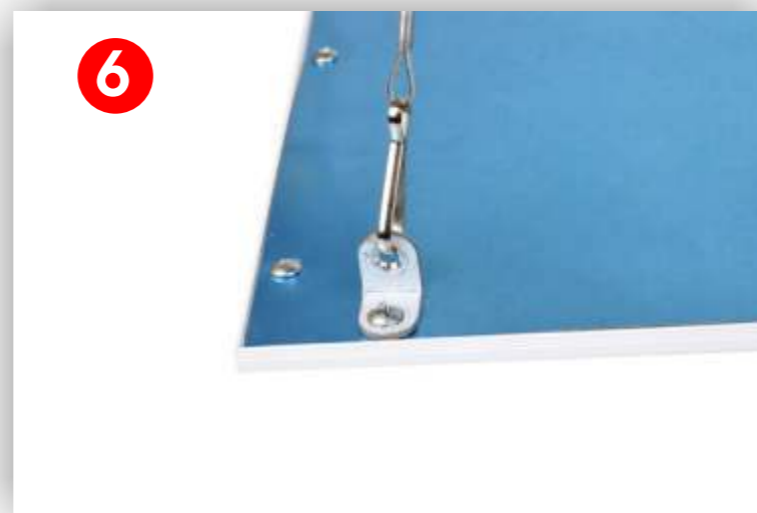

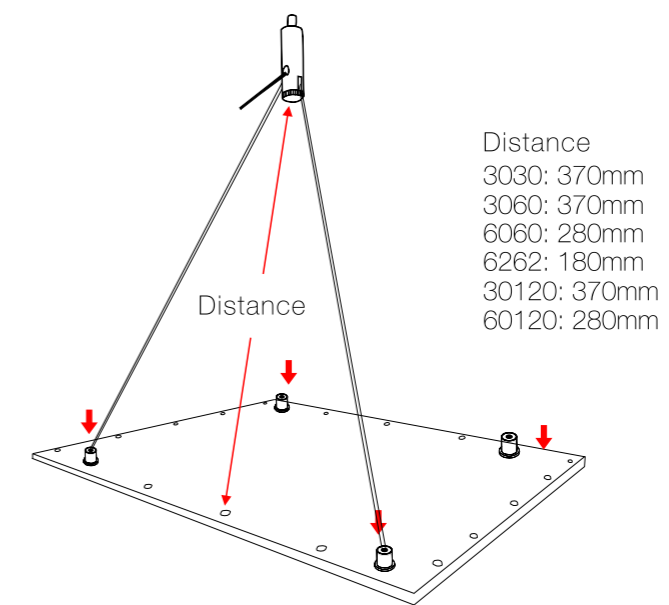

Accessories	3030	3060	6060	6262	30120	60120
		X 2			X 3	
		X 2			X 3	
		X 4			X 6	

Accessories	3030	3060	6060	6262	30120	60120
wire A		X 2			X 3	
wire B		X 2			X 3	

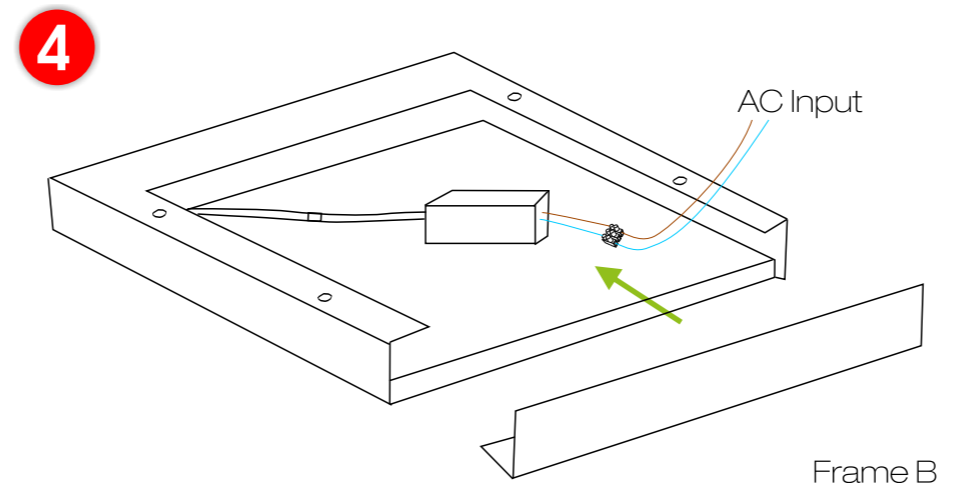
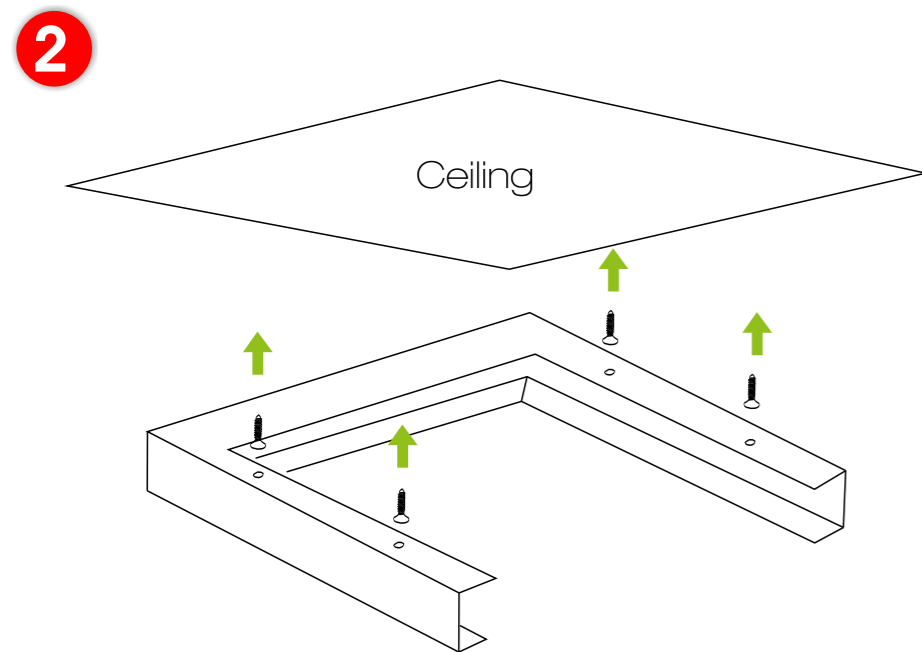
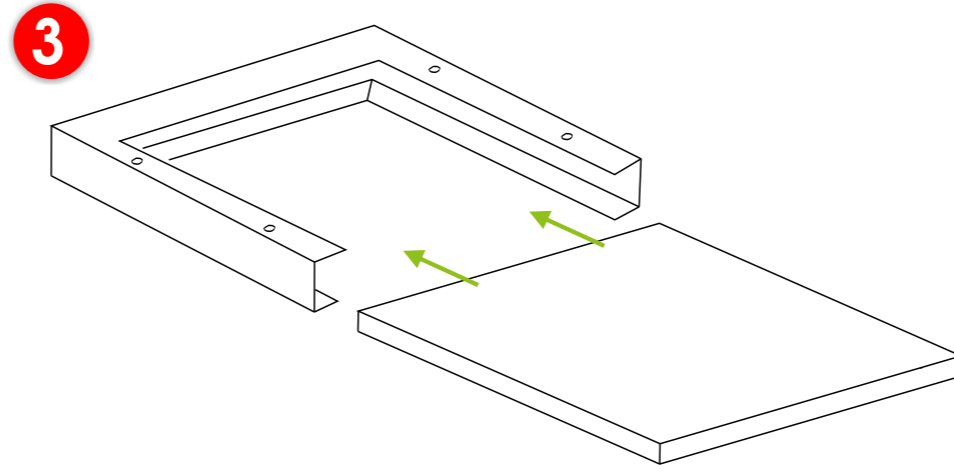
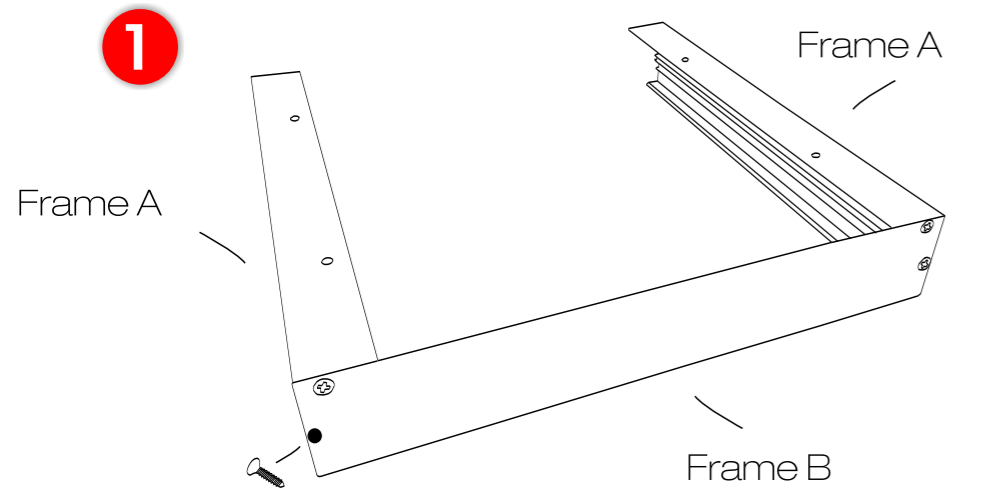

Frame Mounted



Accessories	3030	3060	6060	6262	30120	60120
Frame A		X 2			X 2	
Frame B		X 2			X 2	
		X 8			X 8	
		X 4			X 6	





Ceiling Mounted

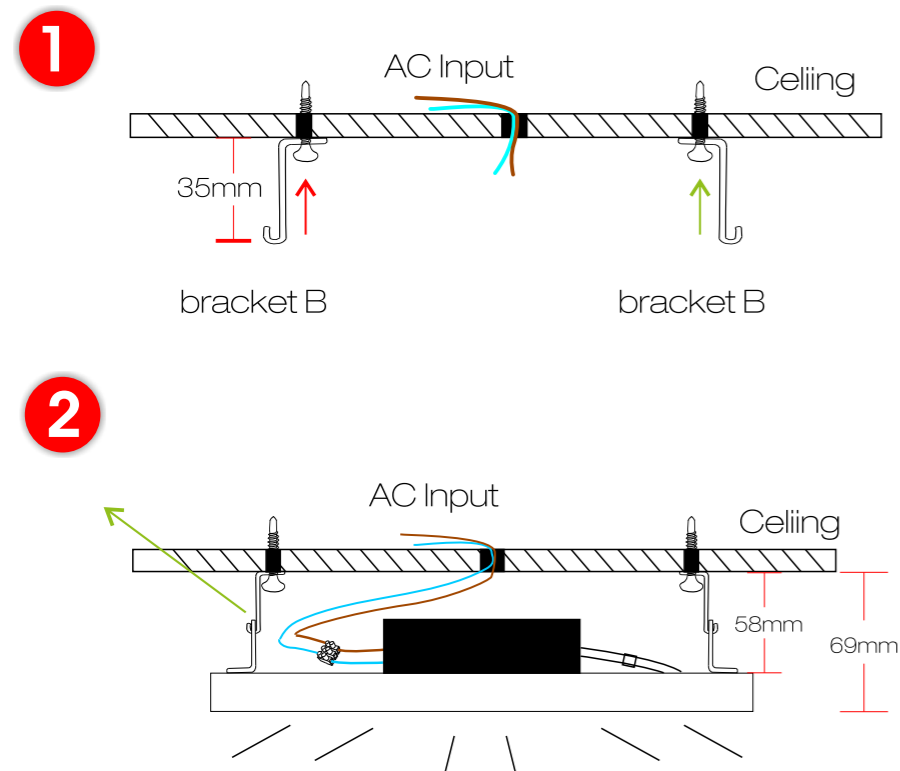

Wall Mounted

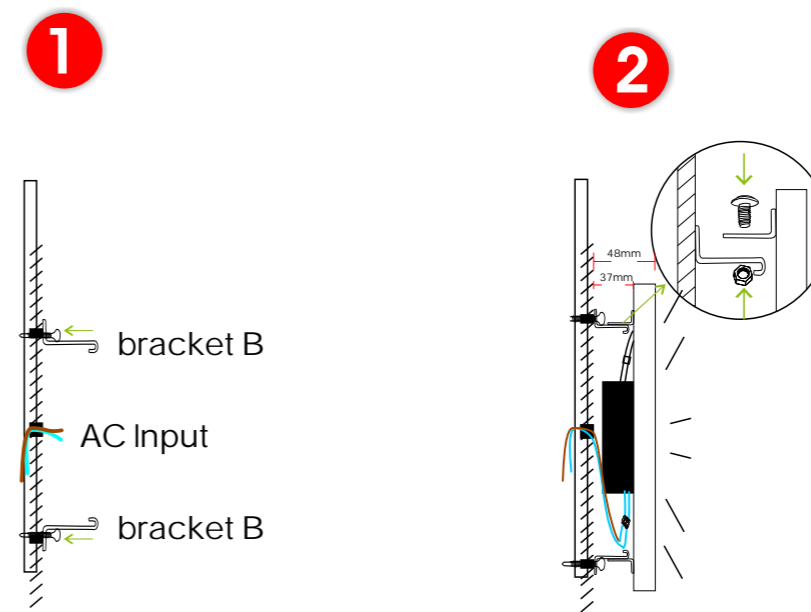

Accessories	3030	3060	6060	6262	30120	60120
bracket A		X 4			X 6	
bracket B		X 4			X 6	
		X 4			X 6	

Accessories	3030	3060	6060	6262	30120	60120
		X 4			X 6	
		X 4			X 6	
		X 4			X 6	

Recessed with Clip

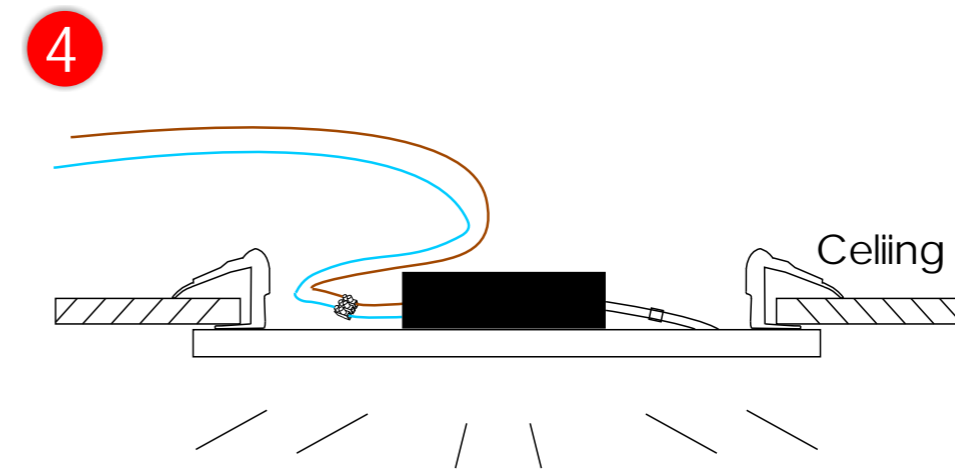
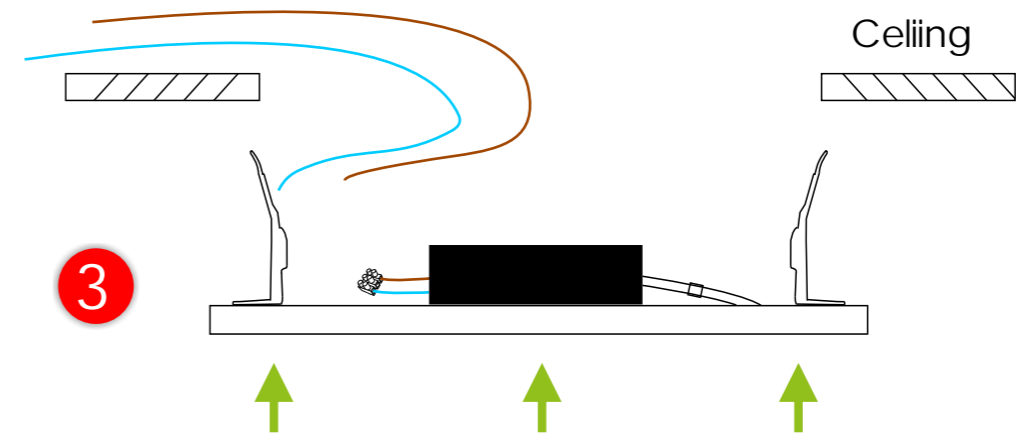
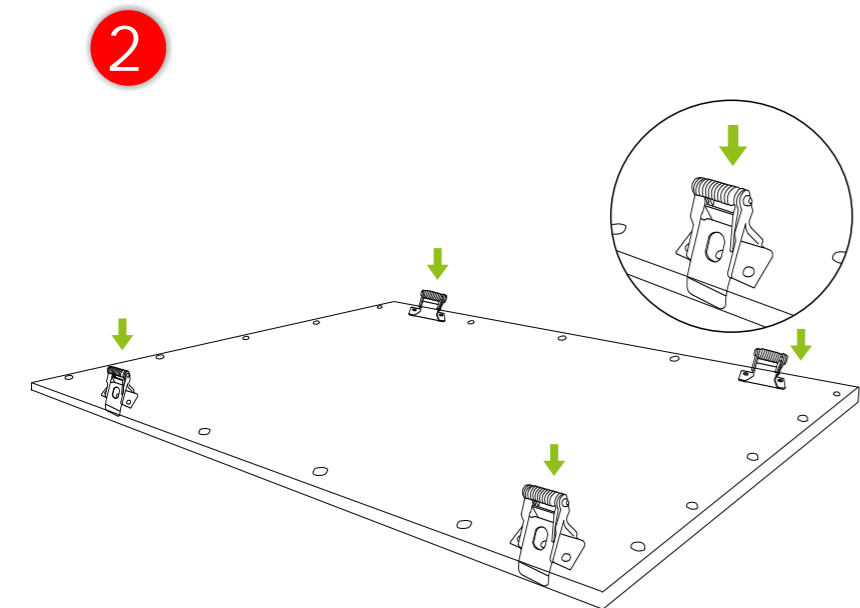
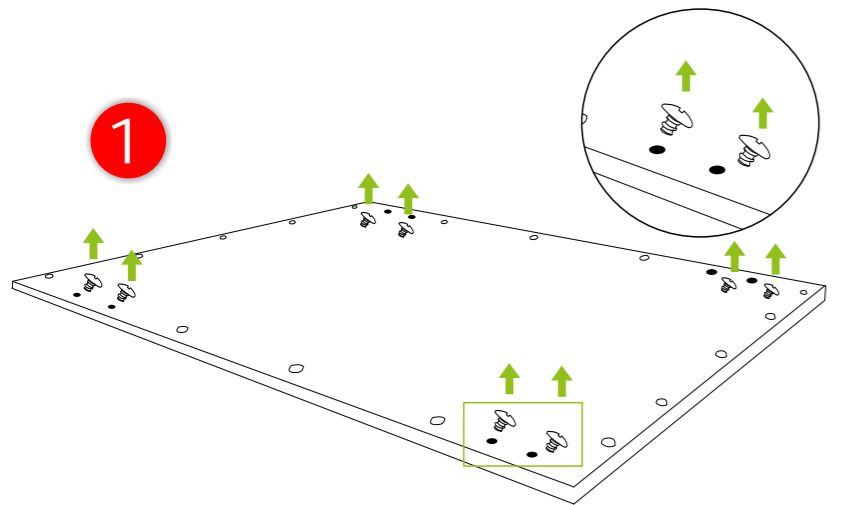

Accessories	3030	3060	6060	6262	30120	60120
			X 4		X 6	

Cut-Out Size:

3030: 280X280mm	6060: 580X580mm
3060: 280X580mm	6262: 600X600mm
30120: 280X1180mm	60120: 580X1180mm

12-26w



MODEL:	TUV-NF-20W	CE-20W	NONCE-20W
Rated power(w):	12-25W	12-22W	12-20W
Rated Input Voltage:	180-240Vac/100-240Vac	180-240Vac/100-240Vac	180-240Vac/100-240Vac
Driver Output Data:	25-38Vdc / 300-550ma	25-38Vdc / 300-500ma	25-38Vdc / 300-450ma
Power Factor:	>90%	>90%	>90%
THD:	<20%	<20%	<20%
Power Effective:	>88%	>88%	>88%
Life Hours:	100,000hrs	50,000hrs	30,000hrs
Warranty:	6yrs	3yrs	2yrs
Surge Protection:	>2KV	>2KV	>1KV
Hi-pot Test Range:	3750Vdc/5mA/60S	3750Vdc/5mA/60S	1500Vdc/5mA/60S
Protection Class IEC:	Class II/Isolated	Class II/Isolated	Class II/Isolated
Flicker Solution:	NON-Flicker	Flicker	Flicker
Dimmable Solution:	NON-Dimmable	NON-Dimmable	NON-Dimmable
Driver/Connection:	Removable Driver / PIP	Removable Driver / PIP	Removable Driver / PIP
Approval:	TUV-MARK/CE/SAA CB/ROHS	TUV-MARK/CE/SAA CB/ROHS	

30-42w



MODEL:	TUV-NF-45W	TUV-40W	LVD-40W	NONCE-40W
Rated power(w):	30-45W	30-43W	30-43W	30-43W
Rated Input Voltage:	180-240Vac/100-240Vac	180-240Vac/100-240Vac	180-240Vac/100-240Vac	180-240Vac/100-240Vac
Driver Output Data:	25-38Vdc / 700-1100ma	25-38Vdc / 700-1050ma	25-38Vdc / 700-1050ma	25-38Vdc / 700-1050ma
Power Factor:	>90%	>90%	>90%	>90%
THD:	<20%	<20%	<20%	<20%
Power Effective:	>88%	>88%	>88%	>88%
Life Hours:	100,000hrs	50,000hrs	50,000hrs	30,000hrs
Warranty:	6yrs	3yrs	3yrs	2yrs
Surge Protection:	>2KV	>2KV	>2KV	>1KV
Hi-pot Test Range:	3750Vdc/5mA/60S	3750Vdc/5mA/60S	3750Vdc/5mA/60S	1500Vdc/5mA/60S
Protection Class IEC:	Class II/Isolated	Class II/Isolated	Class II/Isolated	Class II/Isolated
Flicker Solution:	NON-Flicker	Flicker	Flicker	Flicker
Dimmable Solution:	NON-Dimmable	NON-Dimmable	NON-Dimmable	NON-Dimmable
Driver/Connection:	Removable Driver / PIP	Removable Driver / PIP	Removable Driver / PIP	Removable Driver / PIP
Approval:	TUV-MARK/CE/SAA CB/ROHS	TUV-MARK/CE/SAA CB/ROHS	IEC-LVD	

40-55w



MODEL:	TUV-NF-60W	TUV-60W	LVD-48W
Rated power(w):	45-60W	45-60W	40-48W
Rated Input Voltage:	180-240Vac/100-240Vac	180-240Vac/100-240Vac	180-240Vac/100-240Vac
Driver Output Data:	25-38Vdc / 1000-1400ma	25-38Vdc / 1000-1400ma	25-38Vdc / 1000-1150ma
Power Factor:	>90%	>90%	>90%
THD:	<20%	<20%	<20%
Power Effective:	>88%	>88%	>88%
Life Hours:	100,000hrs	50,000hrs	50,000hrs
Warranty:	6yrs	3yrs	3yrs
Surge Protection:	>2KV	>2KV	>2KV
Hi-pot Test Range:	3750Vdc/5mA/60S	3750Vdc/5mA/60S	3750Vdc/5mA/60S
Protection Class IEC:	Class II/Isolated	Class II/Isolated	Class II/Isolated
Flicker Solution:	NON-Flicker	Flicker	Flicker
Dimmable Solution:	NON-Dimmable	NON-Dimmable	NON-Dimmable
Driver/Connection:	Removable Driver / PIP	Removable Driver / PIP	Removable Driver / PIP
Approval:	TUV-MARK/CE/SAA CB/ROHS	TUV-MARK/CE/SAA CB/ROHS	IEC-LVD/BIS

60-76w

MODEL:	TUV-NF-75W
Rated power(w):	30-45W
Rated Input Voltage:	180-240Vac/100-240Vac
Driver Output Data:	25-38Vdc / 1400-1800ma
Power Factor:	>90%
THD:	<20%
Power Effective:	>88%
Life Hours:	100,000hrs
Warranty:	6yrs
Surge Protection:	>2KV
Hi-pot Test Range:	3750Vdc/5mA/60S
Protection Class IEC:	Class II/Isolated
Flicker Solution:	NON-Flicker
Dimmable Solution:	NON-Dimmable
Driver/Connection:	Removable Driver / PIP
Approval:	TUV-MARK/CE/SAA CB/ROHS